

CATÁLOGO DE PRODUCTOS

Catalogue

Katalog



GRANITOS
TENΛ

ÍNDICE

Index

1. **Sobre Nosotros** / About Us / Über uns
2. **Materiales para Obra Pública** / Cut to Size / Materialien für öffentliche Arbeiten
3. **Tablas de Granito** / Slabs / Granit-Platten
4. **Arte Funerario** / Cemetery / Begräbniskunst
5. **Bloques en Bruto** / Raw Blocks / Grobe Blöcke
6. **Otros Productos** / Other Products / Andere Produkte
7. **Contacto** / Contact Info / Kontakt

Sobre Nosotros

About Us
Über uns



LA EMPRESA

The Company / Das Unternehmen

En Granitos Tena S.L. llevamos más de veinte años explotando nuestras canteras y elaborando multitud de productos relacionados con el granito. Actualmente explotamos cinco canteras, de las que extraemos seis tipos diferentes de granitos, de los cuales cinco son totalmente exclusivos. De igual forma, nuestra empresa sigue haciendo esfuerzos con el objetivo de seguir creciendo y ofrecer a nuestros clientes un servicio más cercano, con un amplio abanico de productos.

Siempre hemos seguido unos principios y valores, gracias a los cuales hemos construido la confianza de nuestros clientes, tanto a nivel internacional como nacional, basándonos en el compromiso, la seriedad, puntualidad, honestidad y responsabilidad que siempre nos ha caracterizado para así ofrecer la más alta calidad tanto en nuestros productos como en nuestro servicio.

Actualmente contamos con procesos de fabricación con la más moderna maquinaria y últimas tecnologías del sector, con el fin de hacer frente a las necesidades de los mercados en lo que se refiere a calidad del producto y fiabilidad en los plazos de entrega.

Además, trabajamos desde hace años en la introducción de nuestros granitos en los mercados extranjeros, como son el estadounidense y otros mercados europeos. Para este propósito, contamos con un grupo de personal con conocimientos en idiomas y comercio internacional.

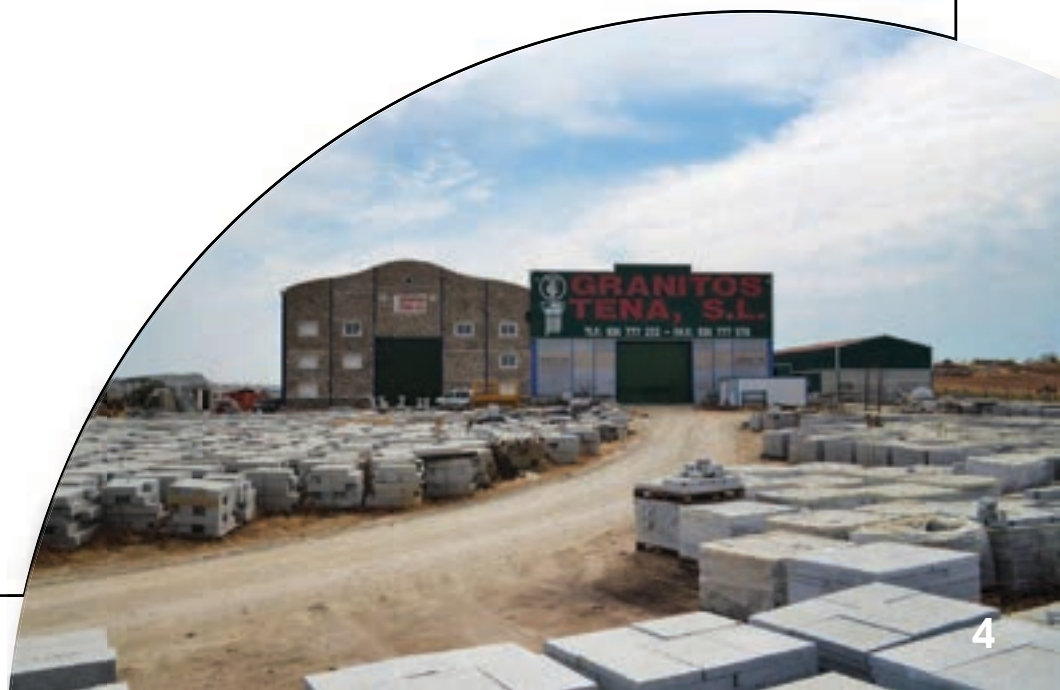

In Granitos Tena S.L. we have been exploiting our quarries for more than twenty years and elaborating a multitude of products related to granite. We currently exploit five quarries, from which we extract six different types of granites, five of which are totally exclusive. In the same way, our company continues to make efforts with the aim of continuing to grow and offer our customers a closer service, with a wide range of products.

We have always followed certain principles and values, thanks to which we have built the trust of our customers, both internationally and nationally, based on the commitment, seriousness, punctuality, honesty and responsibility that has always characterized us in order to offer the highest quality in our products and service.

We currently have manufacturing processes with the most modern machinery and latest technologies in the sector, in order to meet the needs of the markets in terms of product quality and reliability in delivery times.

In addition, we have been working for years in the introduction of our granites in foreign markets, such as the American and other European markets. For this purpose, we have a group of personnel with knowledge in languages and international trade.

Wir von Granitos Tena S.L. bewirtschaften unsere Steinbrüche seit mehr als zwanzig Jahren und stellen eine Vielzahl von Granitprodukten her. Derzeit betreiben wir fünf Steinbrüche, aus denen wir sechs verschiedene Granitarten gewinnen, von denen fünf völlig exklusiv sind. Unser Unternehmen ist bestrebt, weiter zu wachsen und unseren Kunden mit einer breiten Produktpalette einen besseren Service zu bieten.

Wir haben uns immer an bestimmte Grundsätze und Werte gehalten, dank derer wir das Vertrauen unserer Kunden auf nationaler und internationaler Ebene gewonnen haben. Dies beruht auf dem Engagement, der Seriosität, der Pünktlichkeit, der Ehrlichkeit und der Verantwortung, die uns seit jeher auszeichnen, um sowohl bei unseren Produkten als auch bei unserem Service die höchste Qualität zu bieten.

Derzeit verfügen wir über Produktionsprozesse mit den modernsten Maschinen und neuesten Technologien des Sektors, um den Anforderungen der Märkte in Bezug auf Produktqualität und Zuverlässigkeit bei den Lieferzeiten gerecht zu werden.

Darüber hinaus arbeiten wir seit Jahren an der Einführung unserer Granite auf ausländischen Märkten, wie dem amerikanischen und anderen europäischen Märkten. Zu diesem Zweck verfügen wir über eine Gruppe von Mitarbeitern mit Sprachkenntnissen und Kenntnissen des internationalen Handels.



NUESTRAS CANTERAS

Our Quarries / Unsere Steinbrüche



NUESTRA FÁBRICA

Our Factory / Unser Werk



UBICACIÓN

Location / Standort

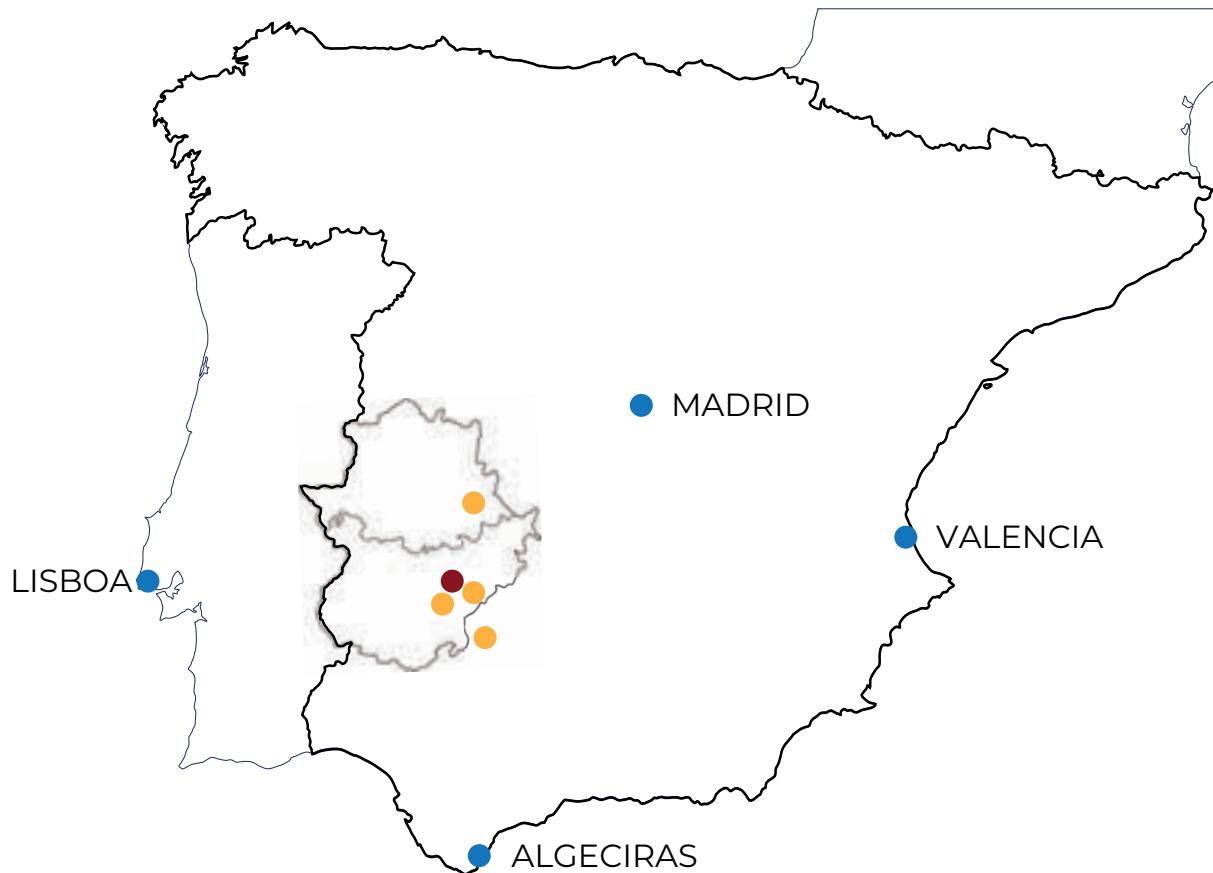

● FÁBRICA
Factory / Fabrik

● CANTERAS
Quarries /
Steinbrüche

● PUERTOS
Ports / Häfen

Materiales para Obra Pública

Cut to Size

Materialien für öffentliche Arbeiten

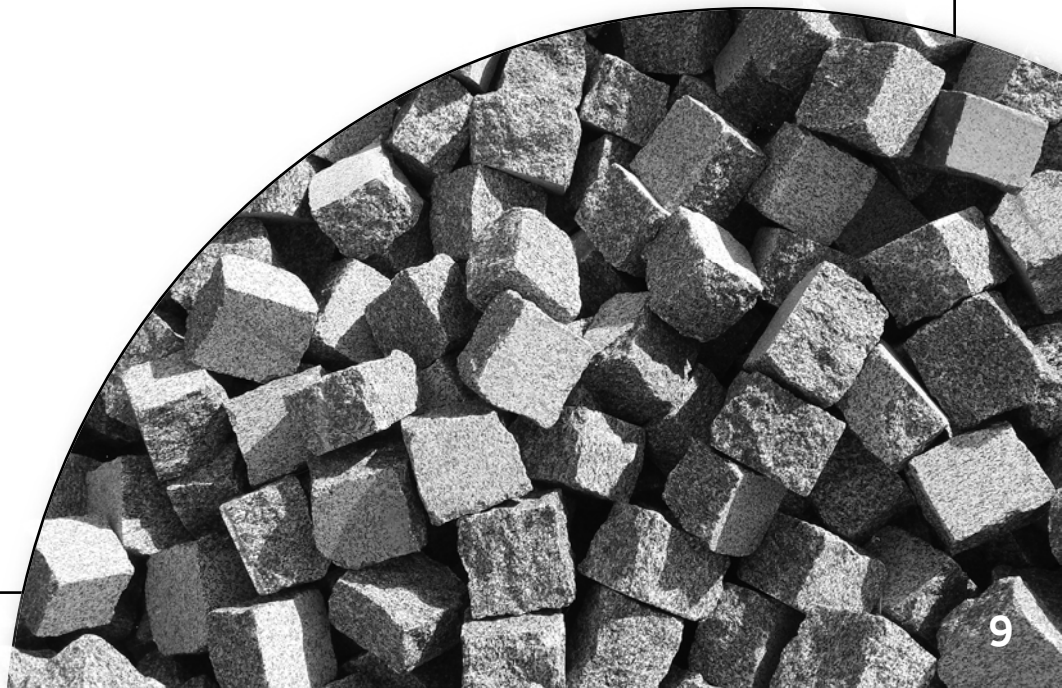

BORDILLOS

Curbs / Bordsteinkanten

Curvos

Curved
Kurven



Radios / Radius / Funkgeräte

8 m
10 m
12 m

Otras medidas disponibles
Other sizes available
Andere Größen verfügbar

Acabados / Finishings / Beendet

Flameado
Serrado

Rectos

Straight
Gerade



Medidas / Sizes /
Maßnahmen

10x24 cm
12x24 cm
20x24 cm

Otras medidas disponibles
Other sizes available
Andere Größen verfügbar

Acabados / Finishings / Beendet

Flameado
Labra Manual

Tipos de Bordillos / Curb Types / Arten von Bordsteinkanten

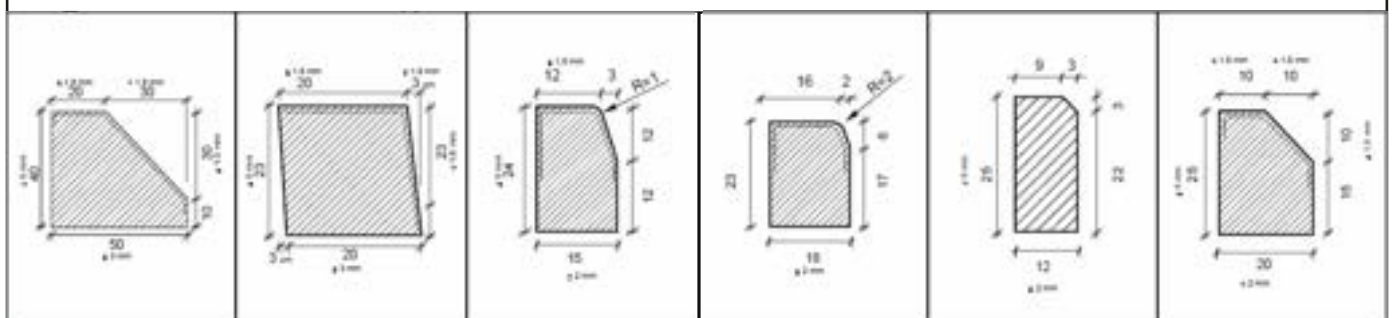

ADOQUINES

Cobblestones / Pflastersteine

Rústico

Rustic
Rustikal



Medidas / Sizes /
Maßnahmen

20x10x5 cm
20x10x8 cm
20x10x10 cm

Otras medidas disponibles
Other sizes available
Andere Größen verfügbar

Acabados / Finishings /
Beendet

Flameado
Rústico

Mecanizado

Mechanized
Mechanisierte



Medidas / Sizes /
Maßnahmen

20x10x5 cm
20x10x6 cm
20x10x8 cm
20x10x10 cm

Otras medidas disponibles
Other sizes available
Andere Größen verfügbar

Acabados / Finishings /
Beendet

Flameado
Agranallado

BALDOSAS

Tiles / Fliesen



Medidas

Sizes / Maßnahmen

40x30 cm

40x40 cm

50x50 cm

60x30 cm

60x40 cm

60x60 cm

Espesores

Thickness / Dicken

2 - 6 cm

8 cm

10 cm

Acabados

Finishings / Beendet

Flameado

Pulido

Agranallado

Apomazado

Cepillado

Flam + Cep

Losas Rayadas y Abotonadas

Striped and Buttoned Tiles

Gestreifte und geknöpfte Platten



Mismos formatos y acabados que las anteriores.

Same formats and finishes as the previous ones.

Gleiche Formate und Ausführungen wie oben.

JARDINERAS

Planters / Pflanzgefäße



BANCOS

Benches / Banken



Tablas de Granito

Slabs
Granit-Platten

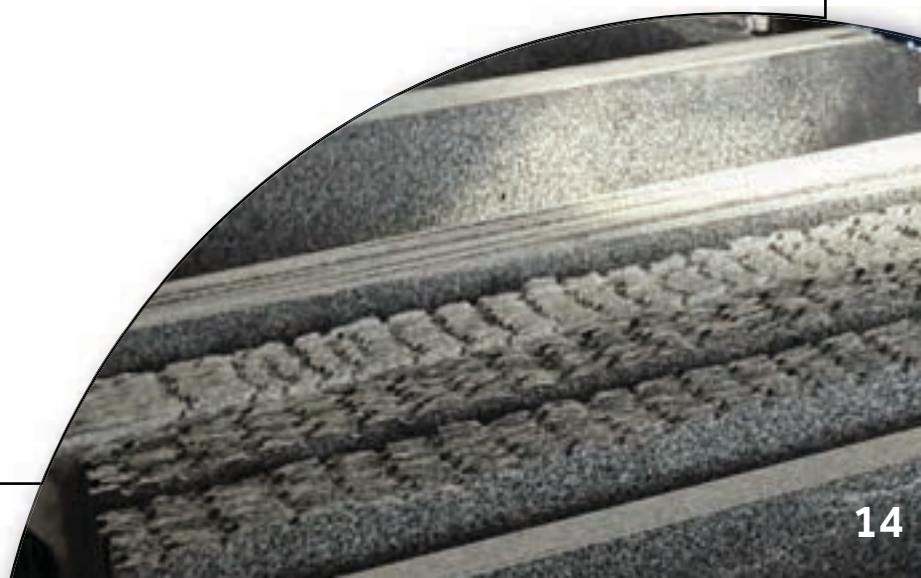

AZUL PLATINO

Cantera Propia
Own Quarry
Eigener Steinbruch

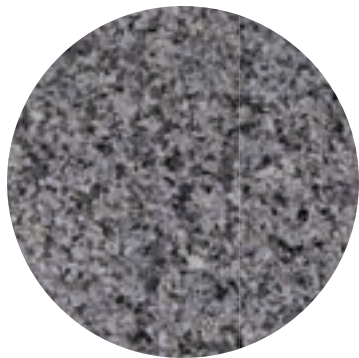
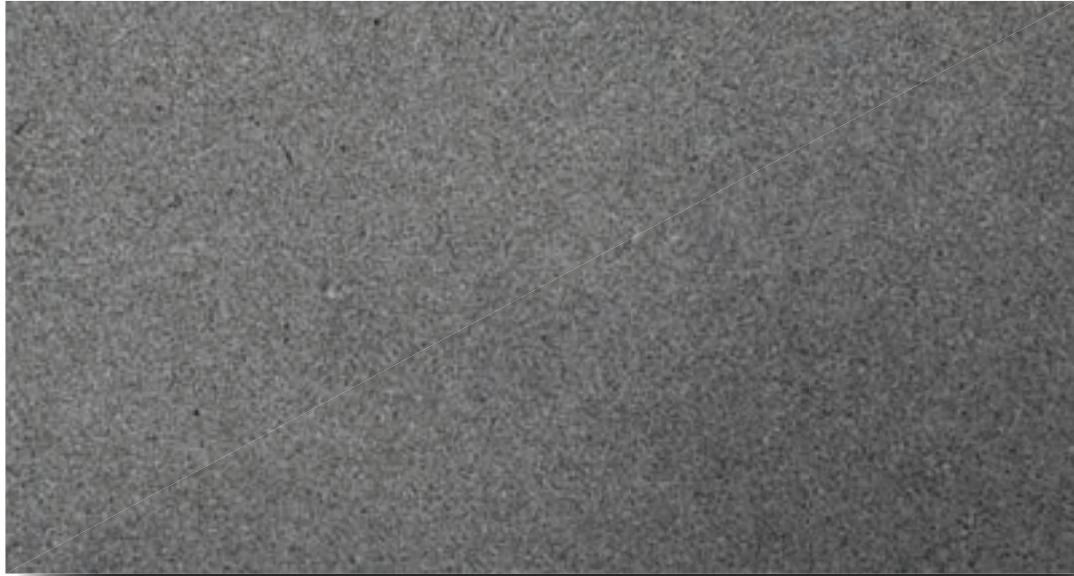

Pulido
Polished
Polieren

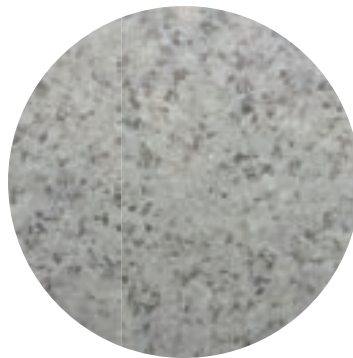

Aserrado
Sawed
Sägen



Abujardado
Sand Blasted
Buschhammer

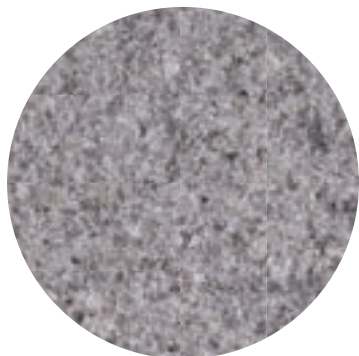

Flameado
Flamed
Flammend

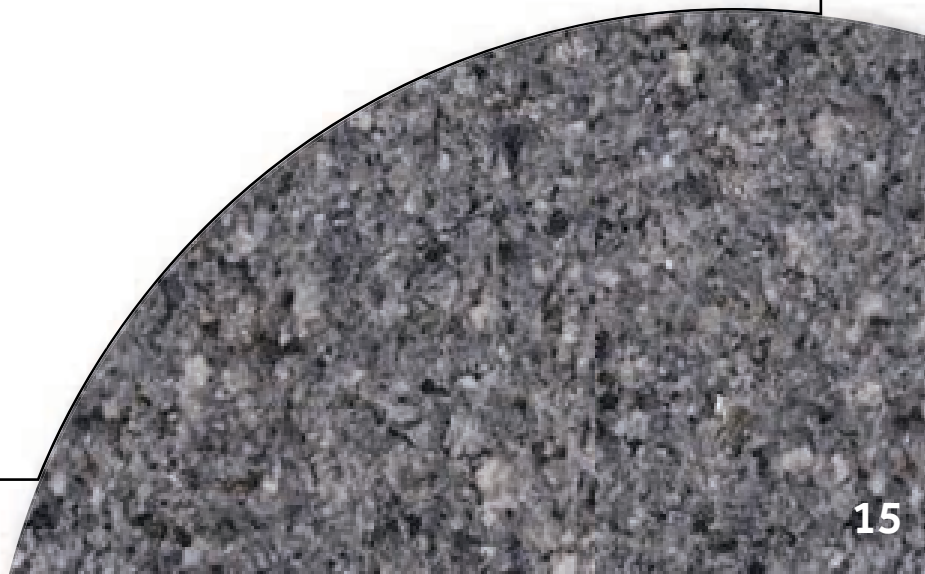

BLANCO AMANECER

Cantera Propia
Own Quarry
Eigener Steinbruch

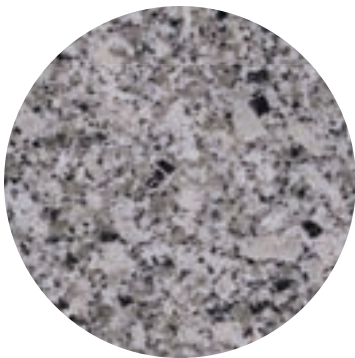

Pulido
Polished
Polieren

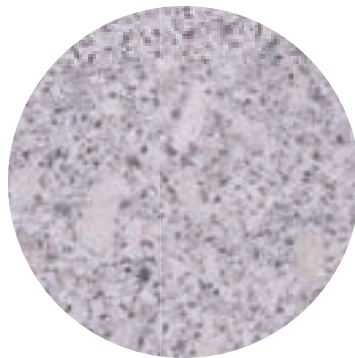

Aserrado
Sawed
Sägen

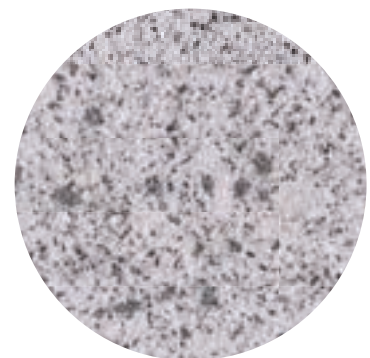

Abujardado
Sand Blasted
Buschhammer



Flameado
Flamed
Flammend

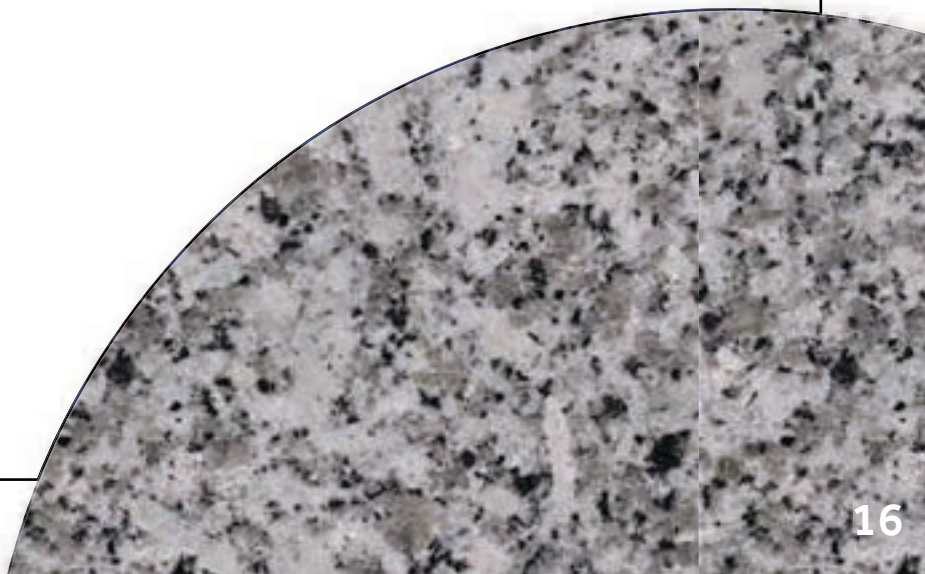

AZUL ANOCHECER

Cantera Propia
Own Quarry
Eigener Steinbruch

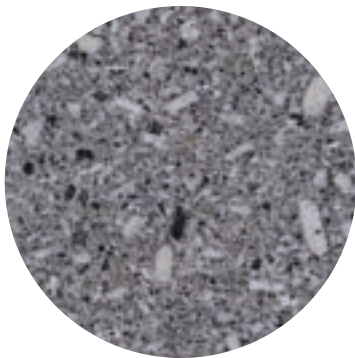

Pulido

Polished
Polieren

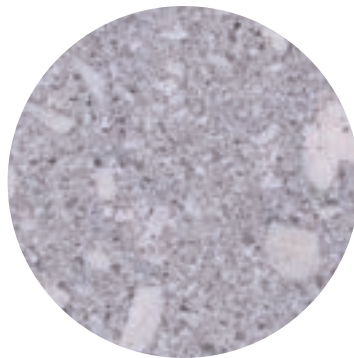

Aserrado

Sawed
Sägen

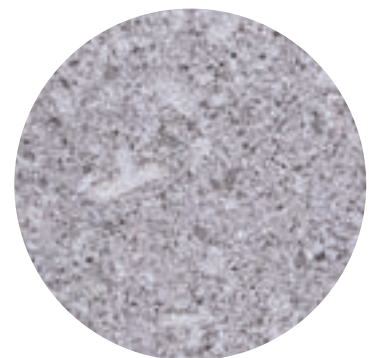

Abujardado

Sand Blasted
Buschhammer

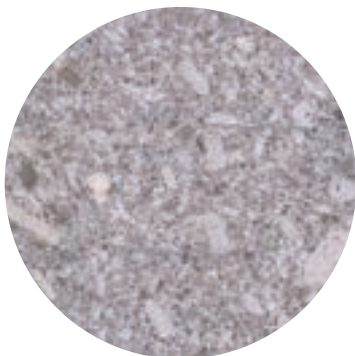

Flameado

Flamed
Flammend

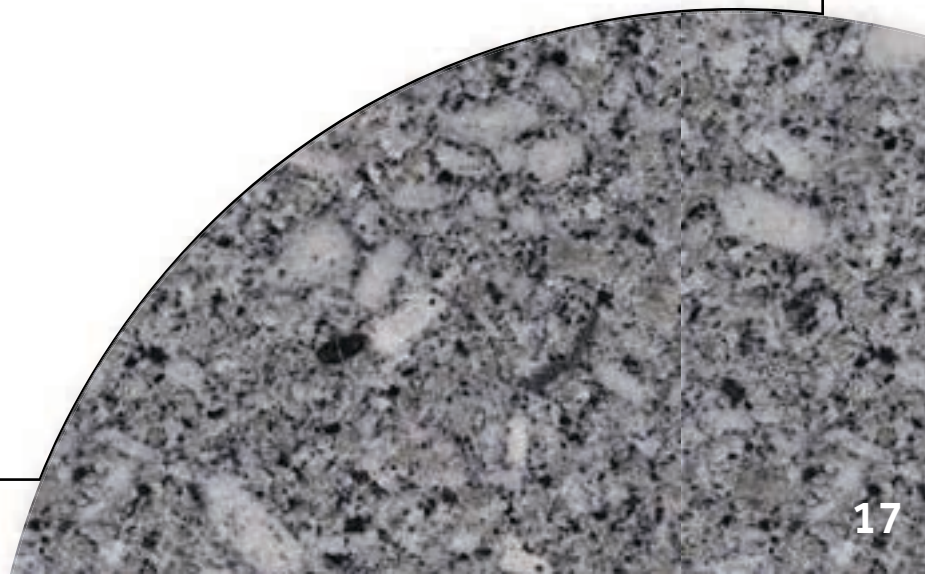

BLANCO FANTASÍA

Cantera Propia
Own Quarry
Eigener Steinbruch

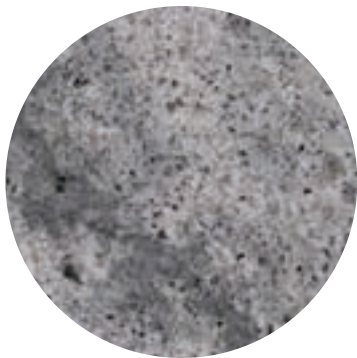
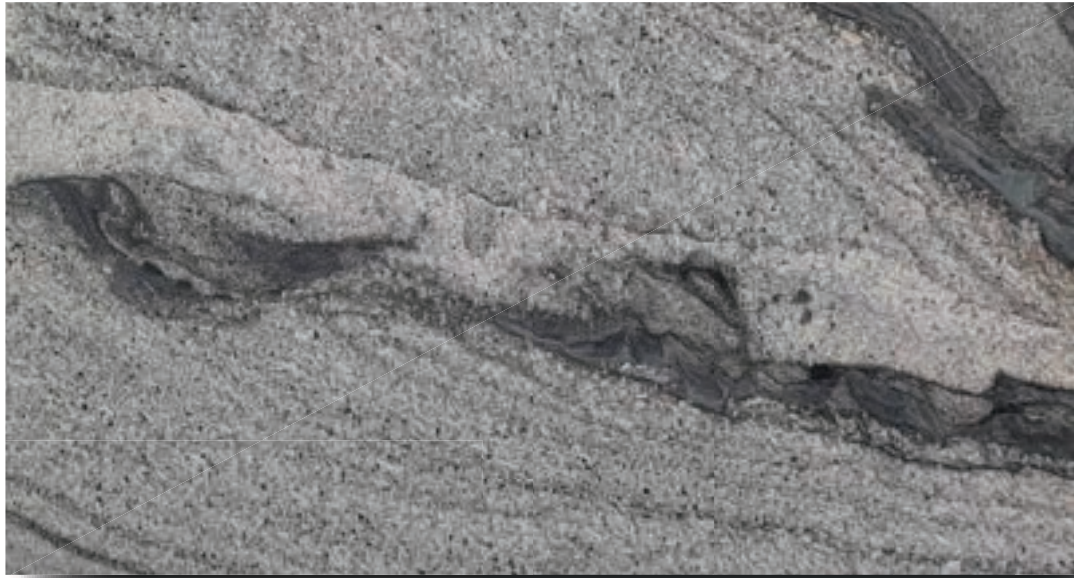

Pulido

Polished
Polieren

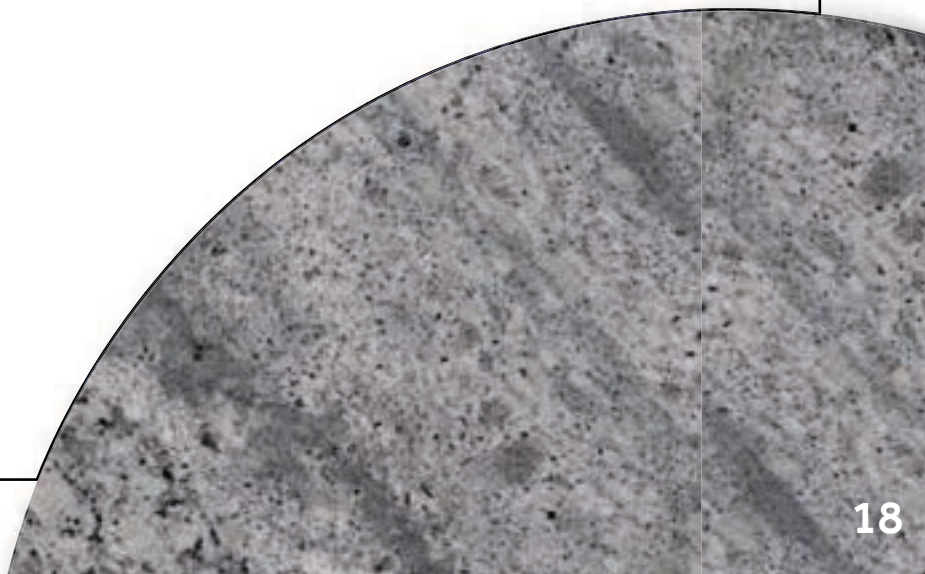

GRIS QUINTANA

Cantera Propia
Own Quarry
Eigener Steinbruch

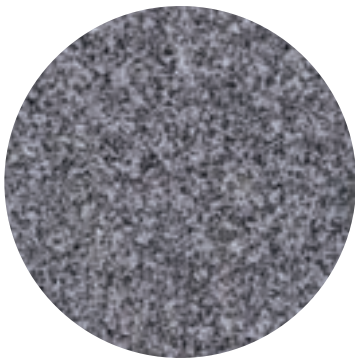

Pulido
Polished
Polieren

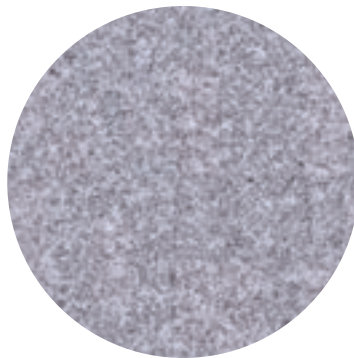

Aserrado
Sawed
Sägen

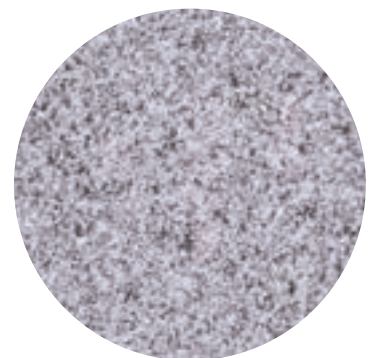

Abujardado
Sand Blasted
Buschhammer

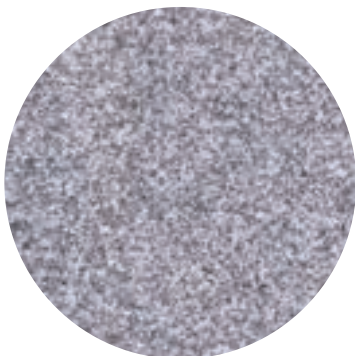

Flameado
Flamed
Flammend

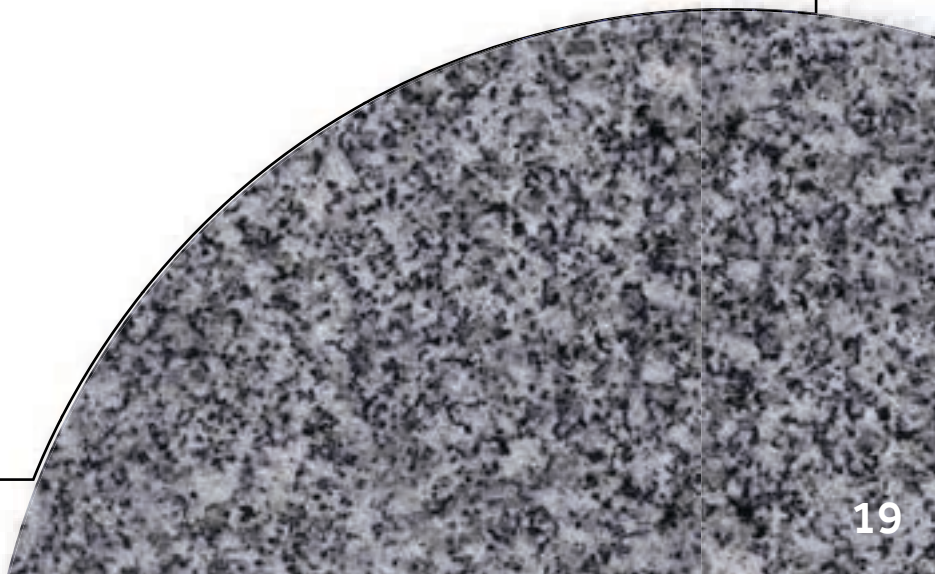

NEGRO TEZAL

Cantera Propia
Own Quarry
Eigener Steinbruch

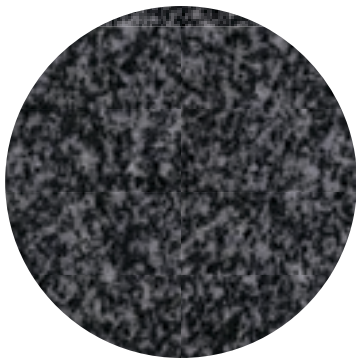
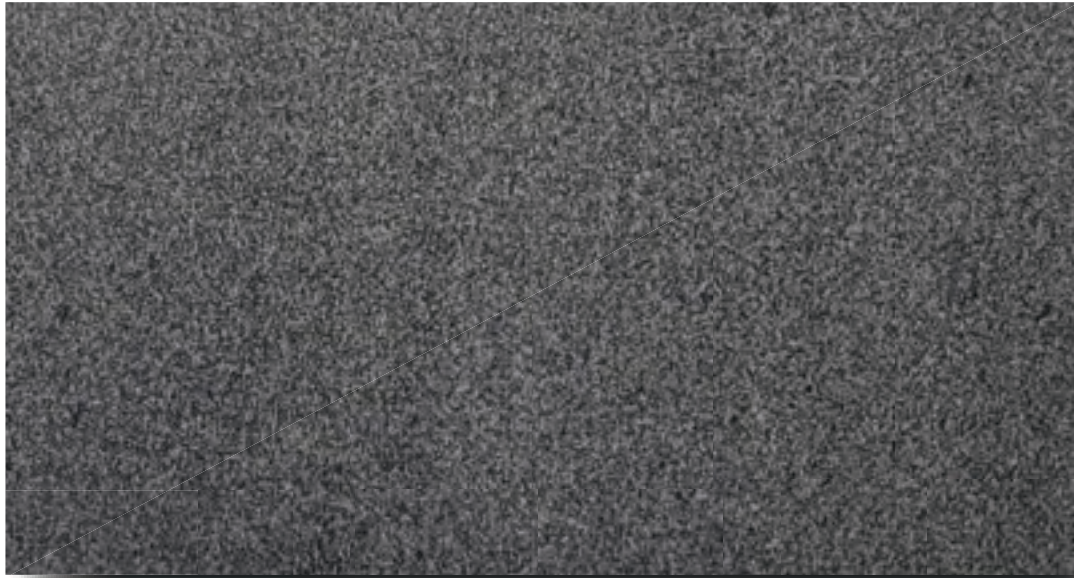

Pulido
Polished
Polieren

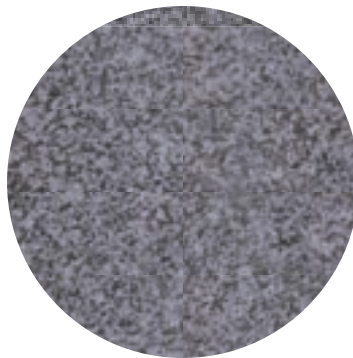

Aserrado
Sawed
Sägen

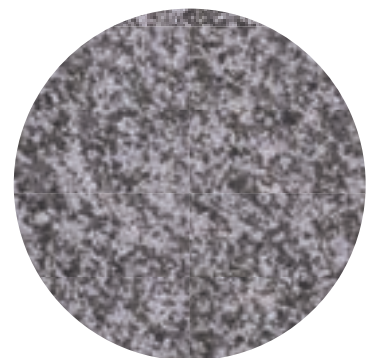

Abujardado
Sand Blasted
Buschhammer

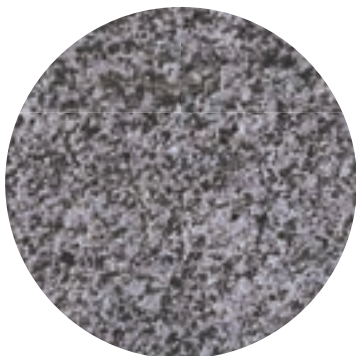

Flameado
Flamed
Flammend

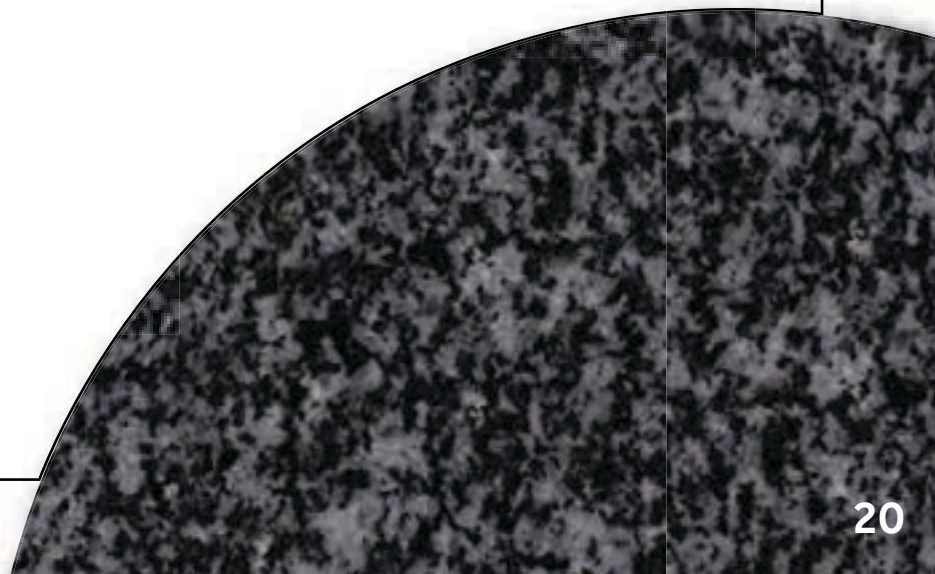

AMARILLO CAMPANARIO

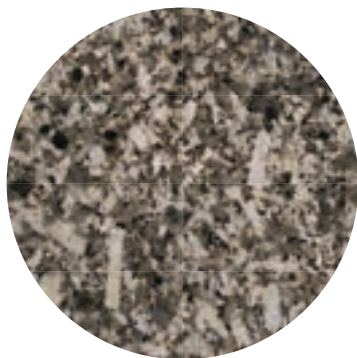

Pulido

Polished
Polieren

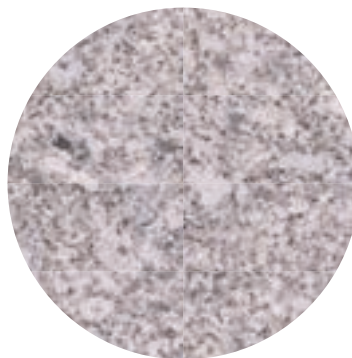

Aserrado

Sawed
Sägen



Abujardado

Sand Blasted
Buschhammer



Flameado

Flamed
Flammend

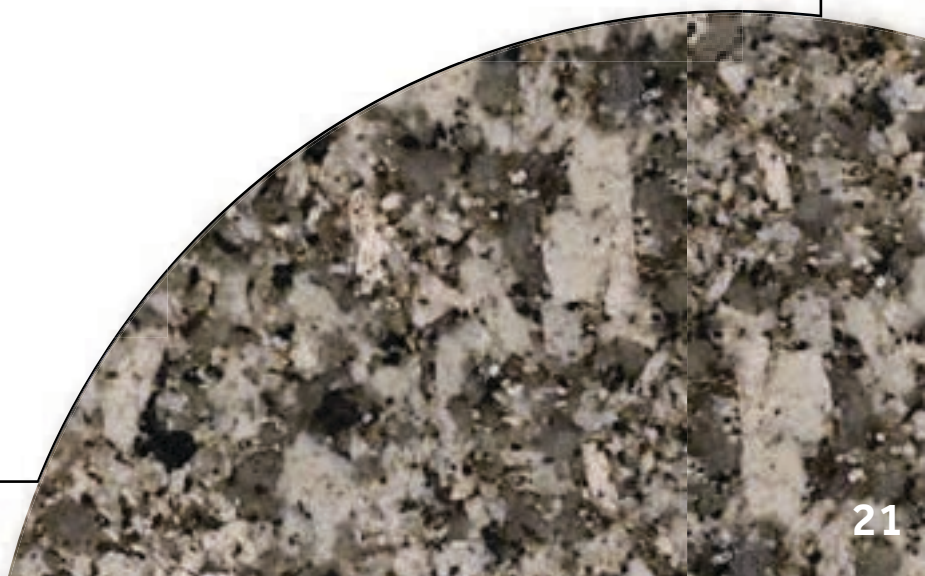

NEGRO OCHAVO ESPECIAL

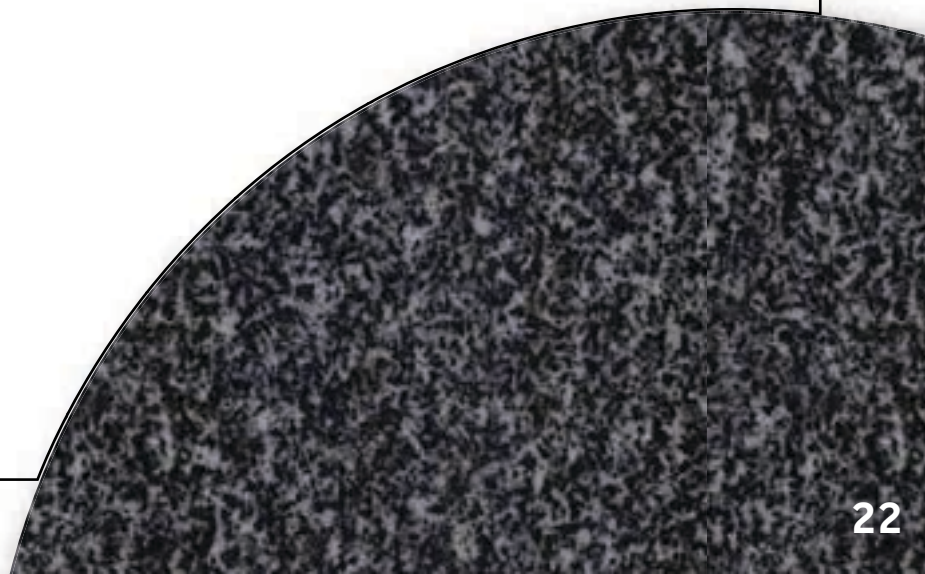

AZUL EXTREMADURA

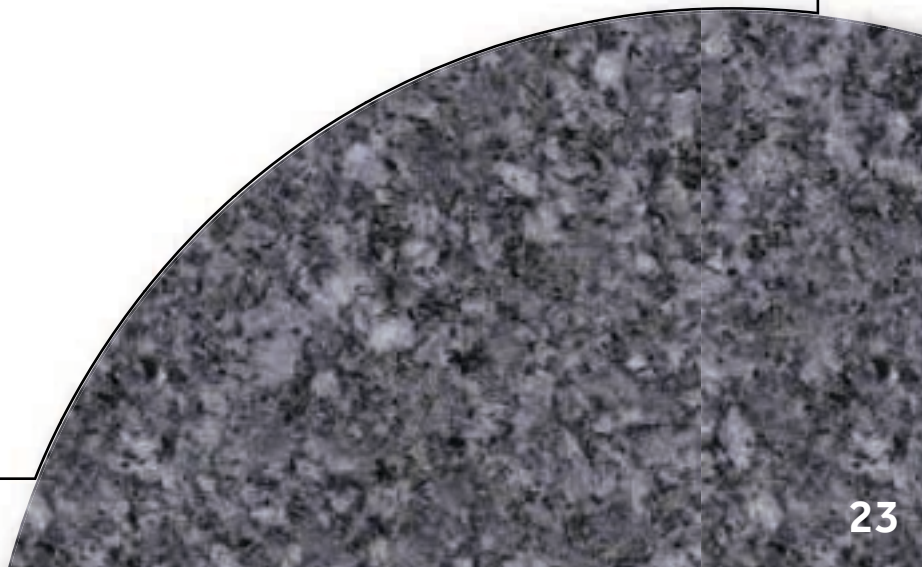

AZUL NOCHE

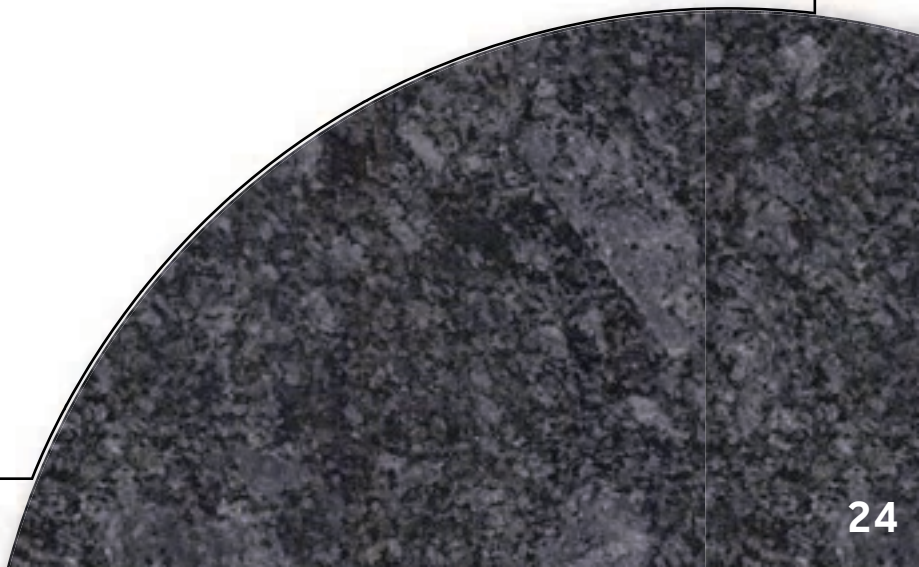
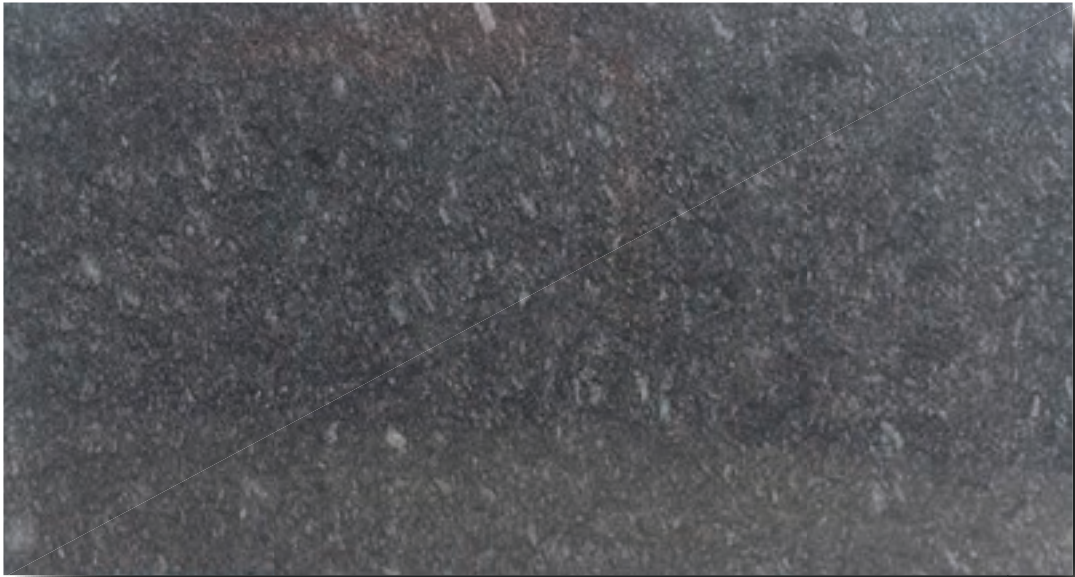

AZUL PLATA

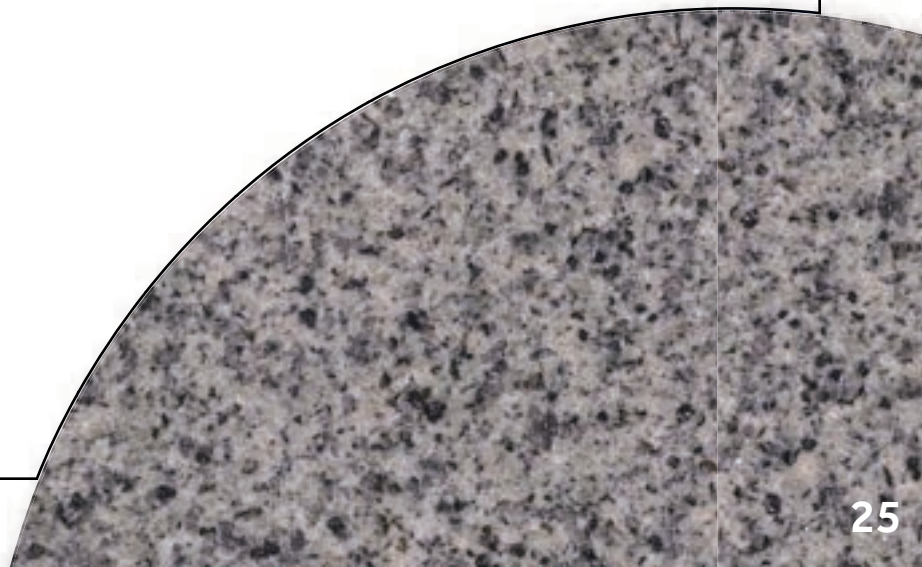

BLANCO PERLA

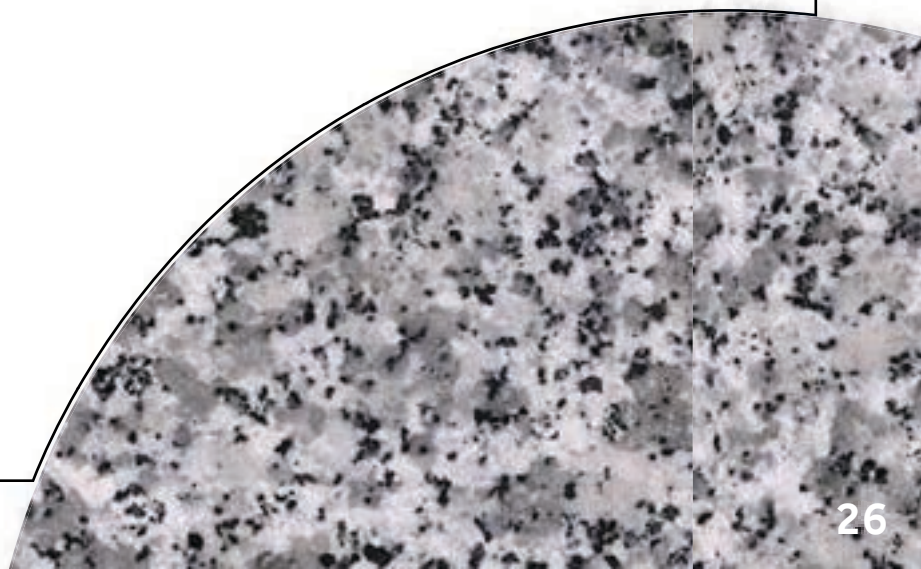

GRAN DORADO

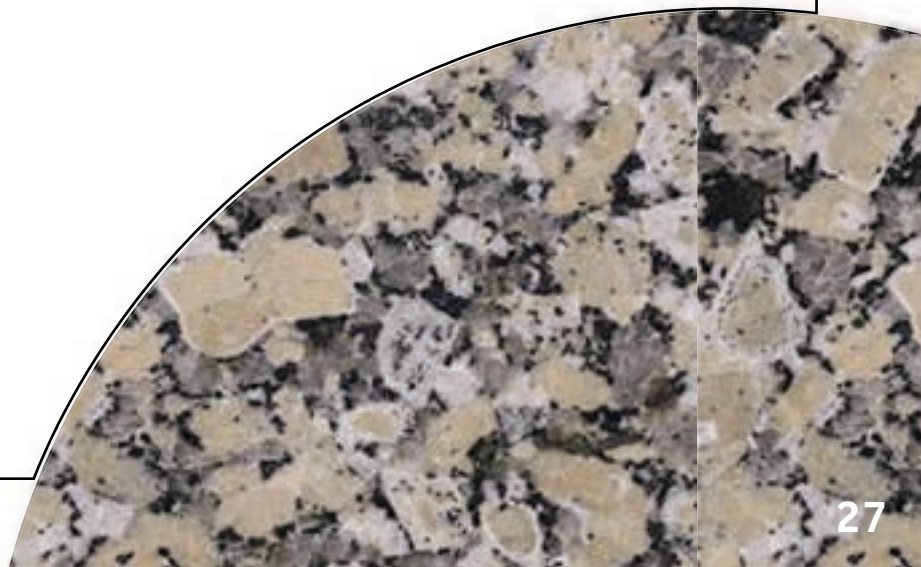

GRIS BADAJOZ

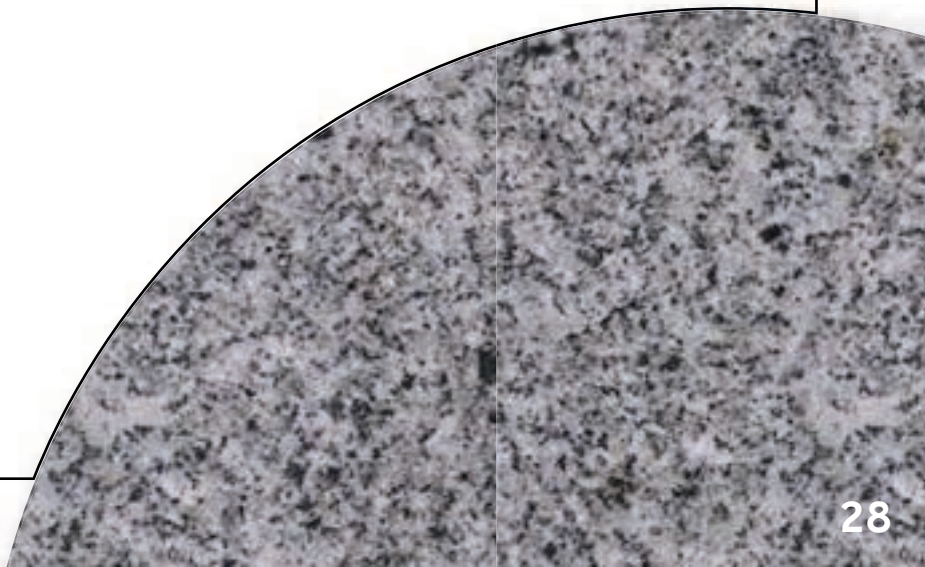

ROJO ARGALLÓN

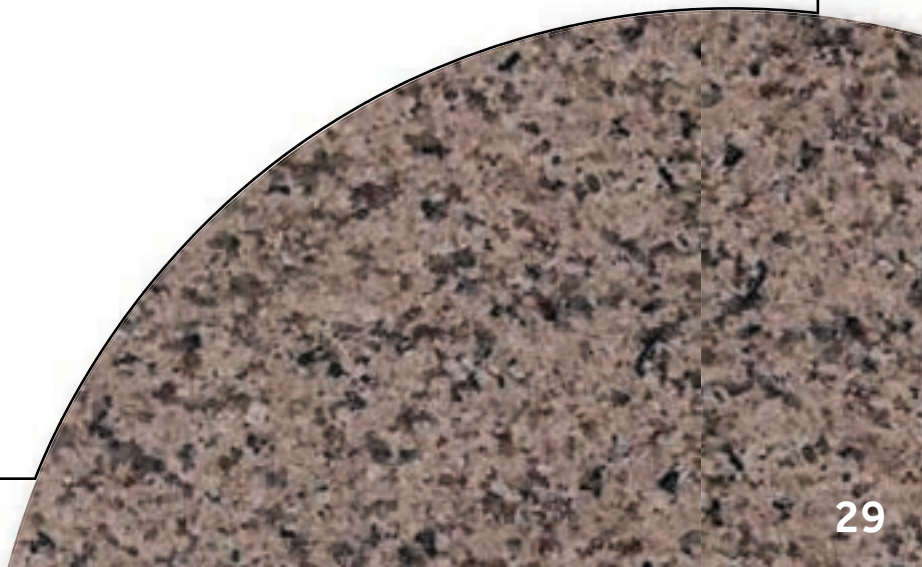

SILVER WHITE

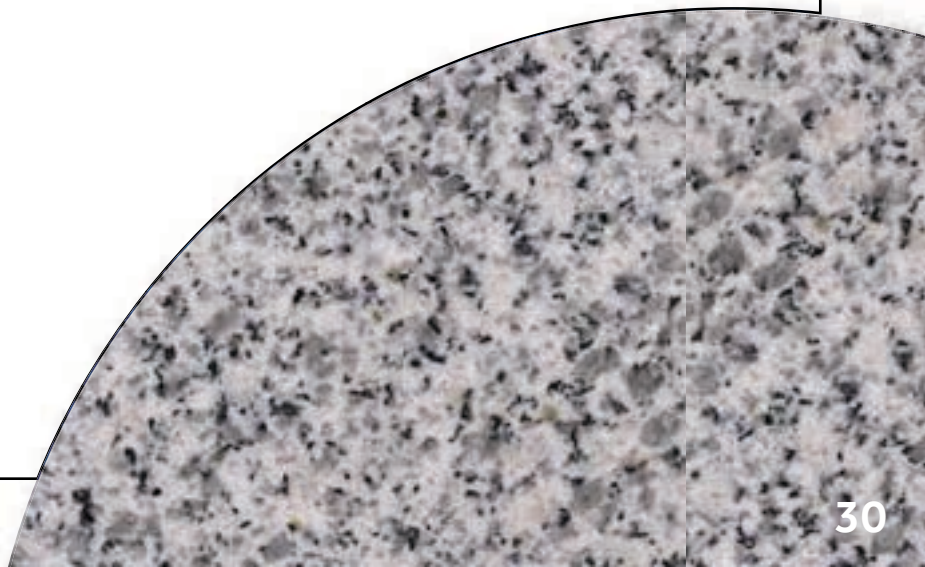

BLANCO CÁCERES

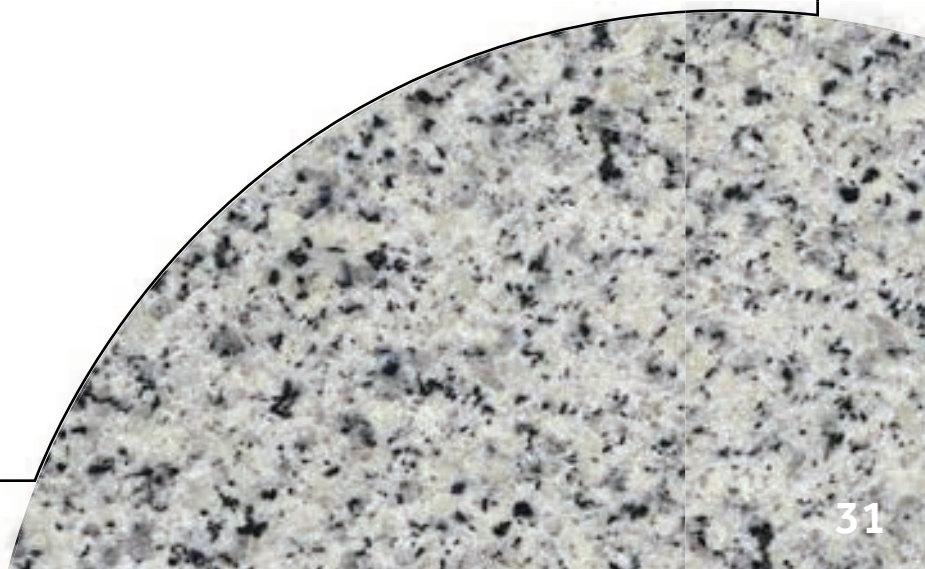

CREMA TENA

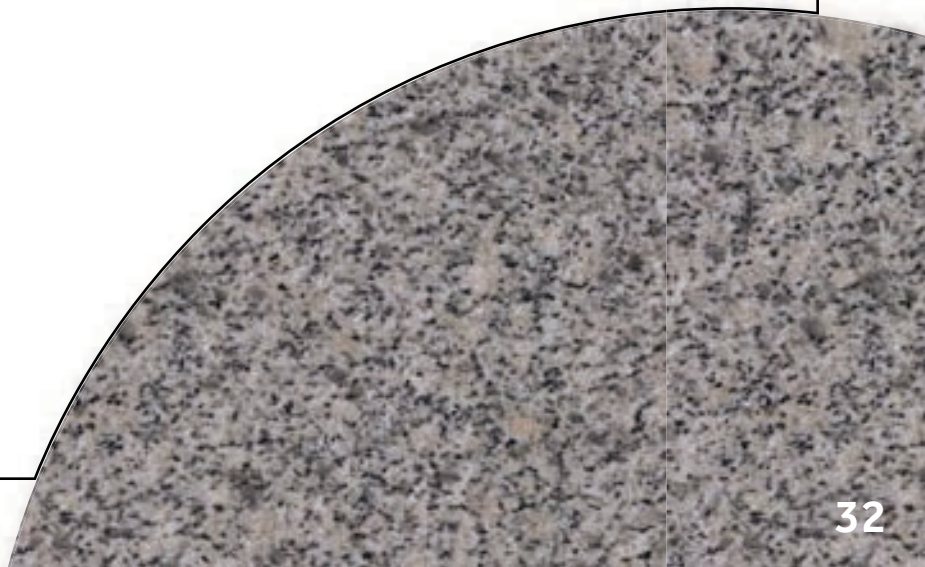

Arte Funerario

Cemetery
Begräbniskunst



TUMBAS SOBRE SUELO

Above-ground Tombs / Oberirdische Gräber



Individuales y Dobles

Single and Double
Einzel und Doppel

Diseños Propios y Bajo Demanda

Own Designs and On
Request
Eigene und
On-Demand-Designs



Lápidas
Tombstones
Grabsteine

TUMBAS SOBRE SUELO

Above-ground Tombs / Oberirdische Gräber



PANTEONES

Pantheons



DECORACIONES

Adornments / Dekorationen



Bloques en Bruto

Raw Blocks
Grobe Blöcke

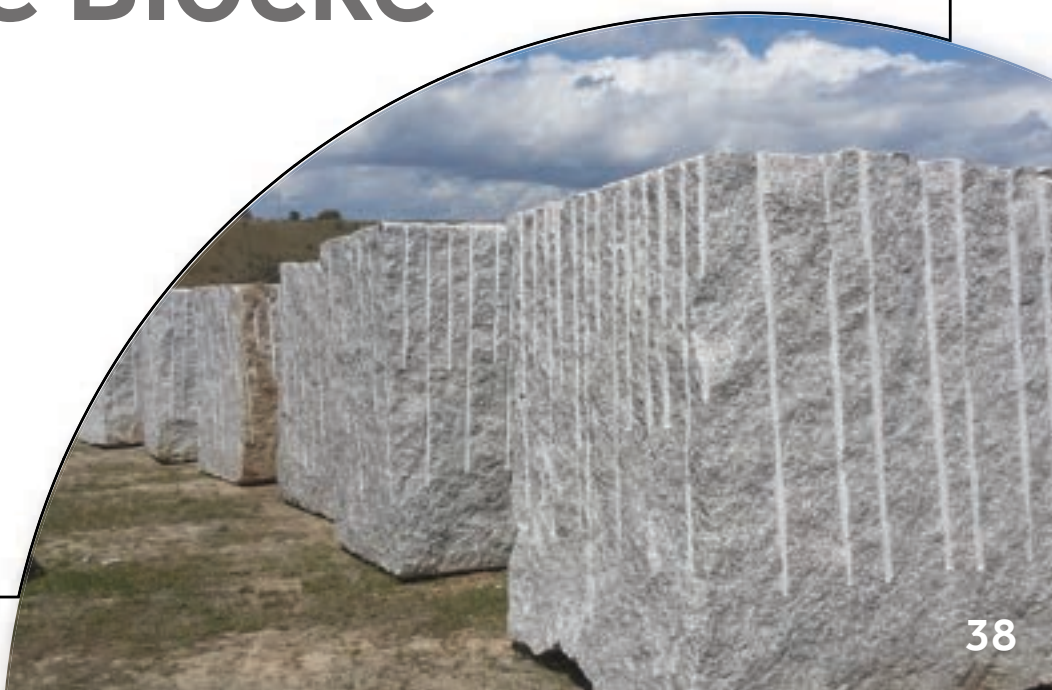

AMARILLO CAMPANARIO

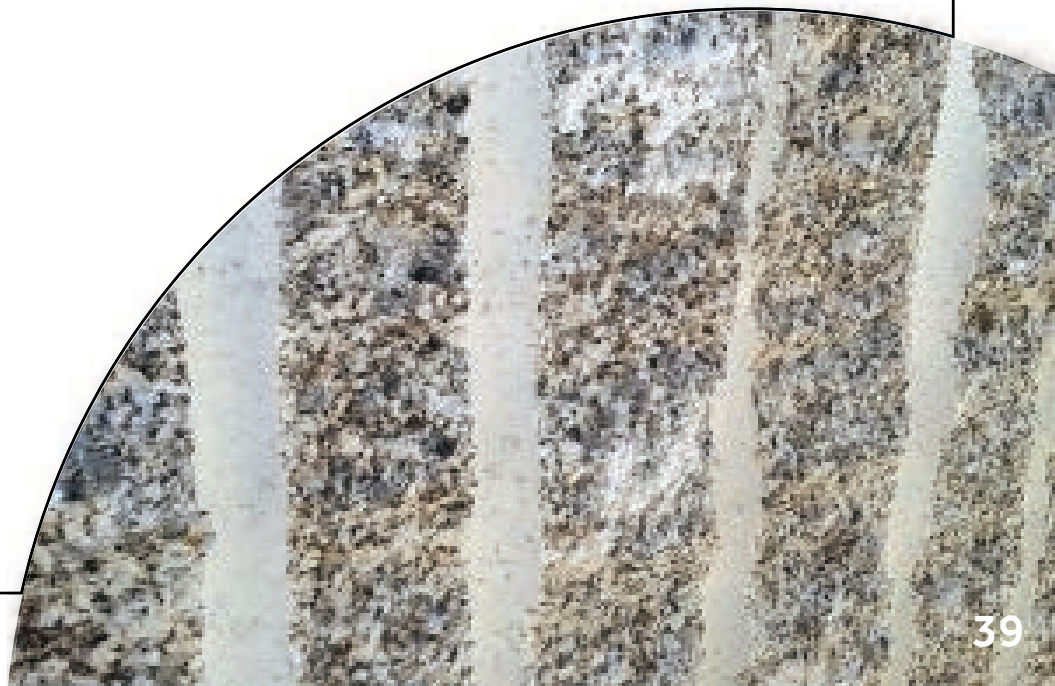

AZUL ANOCHECER



BLANCO AMANECER

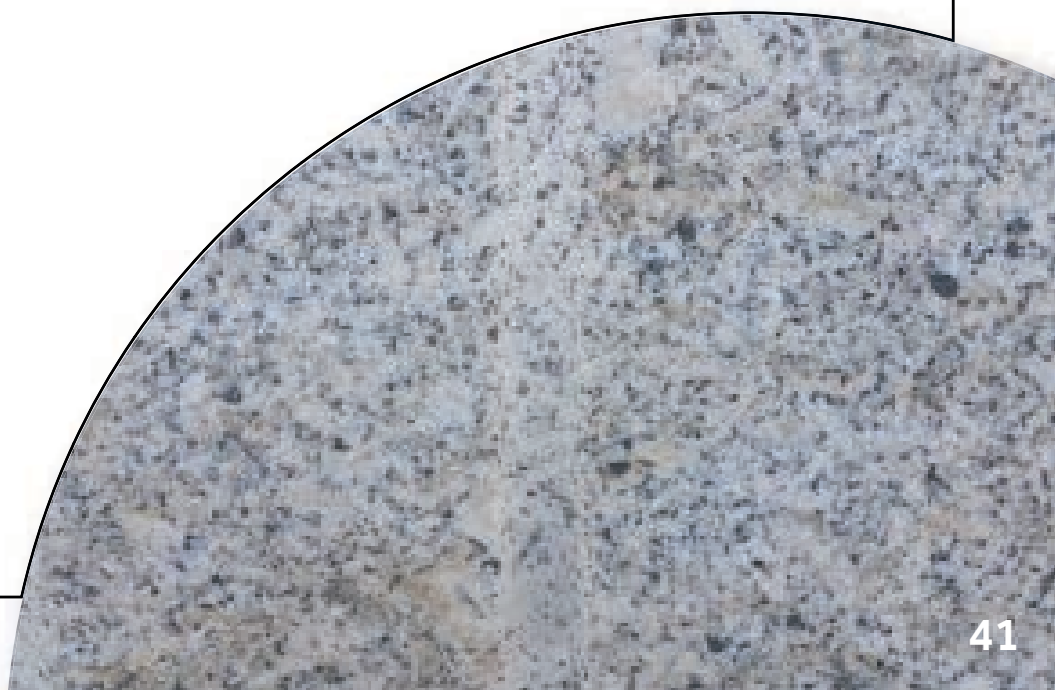

BLANCO FANTASÍA

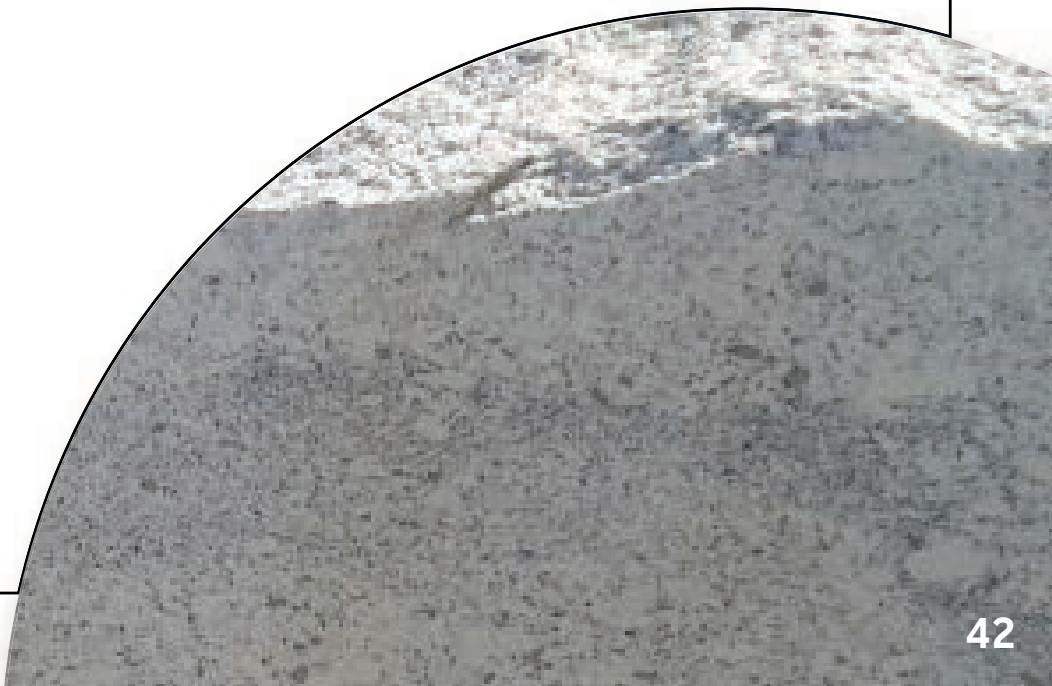

GRIS QUINTANA



NEGRO TEZAL



Otros Productos

Other Products
Andere Produkte



ESCUDOS

Shields / Schilde



CHIMENEAS

Fireplaces / Kamine



FUENTES

Fountains / Quellen



ESCULTURAS

Sculptures / Skulpturen



CONTACTO

Contact Info/ Kontakt



Zurbarán, 80
06450 Quintana de la Serena
Badajoz, España (Spain).



+34 924 777 232
+34 924 777 578



www.granitostena.com



Oficina: info@granitostena.com
Exportación: export@granitostena.com
Logística: agustin@granitostena.com
Nacional: david@granitostena.com



GRANITOS
TEN A



Piedra Natural
de Extremadura



UNIÓN EUROPEA
Fondo Europeo de
Desarrollo Regional